

HEMINGWAY

Design Francesco Lucchese

26 elementi componibili + 1 pouf + 6 elementi individuali, ognuno dei quali disponibile con cuscinatura liscia o capitonné.

Struttura in legno con cinghie elastiche, con tamponi in poliuretano espanso, rivestita in fibra accoppiata con maglina.

Struttura schienale in legno e metallo imbottita in poliuretano espanso a quote differenziate e rivestita in fibra accoppiata con maglina.

Supporto schienale in metallo con parti a vista cromate.

Modello provvisto di meccanismo che permette lo spostamento dello schienale, riducendo la profondità di seduta di 25 cm.

Cuscini schienale e cuscinetti/ruolo bracciolo in piuma rivestiti in cotone.

Cuscini di seduta in poliuretano espanso a quote differenziate rivestiti in cotone accoppiato.

Bracciolo imbottito con struttura in legno con imbottitura in poliuretano espanso rivestito in fibra accoppiata con maglina oppure bracciolo in lamiera curvata rivestita in cuoio.

Piedini in metallo verniciati a polvere con puntale antiscivolo.

Elementi rivestiti in tessuto completamente sfoderabili; elementi rivestiti in pelle con cuscinatura sfoderabile e struttura (base e schienale) non sfoderabili.

26 éléments modulaires + 1 pouf + 6 éléments individuels.

Chaque élément est disponible en deux versions: avec assise et dossier lisses ou matelassés.

Structure en bois, courroies élastiques, tampon en polyuréthane expansé, revêtu de fibre unie à de la maille fine.

Structure du dossier en métal et bois, avec tampon en polyuréthane expansé à niveaux différenciés, revêtement en fibre unie à de la maille fine.

Support du dossier en métal avec détails chromés.

Modèle équipé d'un mécanisme qui permet au dossier d'avancer, avec diminution de la profondeur de l'assise de 25 cm.

Coussins du dossier, coussins déco et coussins cylindriques en plume, revêtus de coton.

Coussins d'assise en polyuréthane expansé à niveaux différenciés revêtus en coton compensé.

Accoudoir rembourré avec structure en bois, tampon en polyuréthane expansé et revêtement de fibre unie à de la maille fine ou accoudoir en tôle arrondie, rembourré en cuir sellerie.

Pieds en métal anti-dérapage vernis à poudre.

Éléments revêtus de tissu, entièrement déhoussables; éléments revêtus en cuir avec coussins entièrement déhoussables et structure (base et dossier) non déhoussable.

26 modular elements + 1 ottoman + 6 individual elements.

Each element is available in 2 versions: with plain or quilted seat and backrest.

Wooden frame with elastic straps, with pad in expanded polyurethane, fibre covering matched with jersey.

Backrest frame in metal and wood, with pad in expanded polyurethane foam in differentiated densities, fibre covering matched with jersey.

Backrest support in metal with chrome-plated details.

Model fitted with a mechanism that enables the backrest to move forward, decreasing the seat depth of 25 cm.

Backrest feather cushions and feather throw pillows/roll cushions upholstered in cotton.

Seat cushions in polyurethane foam in differentiated densities upholstered in heavy cotton.

Padded armrest with wooden frame, upholstered in polyurethane foam fiber covering matched with jersey or armrest in curved sheet metal, upholstered in coach hide.

Feet in metal, powder coated, with non-slip ferrules.

Elements upholstered in completely removable fabric; elements upholstered in leather with cushions having removable covers and structure (base and backrest) with non removable covers.

26 Anbauelemente + 1 Hocker + 6 Einzelemente.

Jedes Element ist in zwei Varianten erhältlich: mit glatten oder gesteppten Sitzkissen und Rückenlehne.

Holzstruktur mit elastischen Riemen und Polyurethanschaumstoff-Polsterung mit Kunstfaser/Trikot-Bezug.

Rückenlehnenstruktur aus Metall und Holz mit Polyurethanschaumstoff-Polsterung zu unterschiedlichen Anteilen und Faser/Samt-Bezug.

Rückenlehnensträger aus Metall mit verchromten Details.

Modell mit Mechanismus, der ermöglicht, die Sitztiefe von 25 cm zu verringern.

Rückenkissen und Armlehnekissen/Rollkissen in Daune mit Baumwollbezug.

Sitzkissen aus Daunen mit Einsatz aus Polyurethanschaumstoff zu unterschiedlichen Anteilen und passendem Baumwollbezug.

Gepolsterte Armlehne mit Holzstruktur und Polyurethanschaumstoff-Polsterung mit Kunstfaser/Trikot-Bezug oder Armlehne aus gebogenem Blech mit Bezug aus Sattelleder.

Pulverbeschichtete Metallfüße mit rutschfester Spitze.

Stoffbezogene Elemente komplett abziehbar; Elementen mit Lederbezug mit abziehbaren Kissen und nicht abziehbarem Gestell (Rahmen und Rückenlehne).

ELEMENTI CENTRALI / CENTRAL UNITS

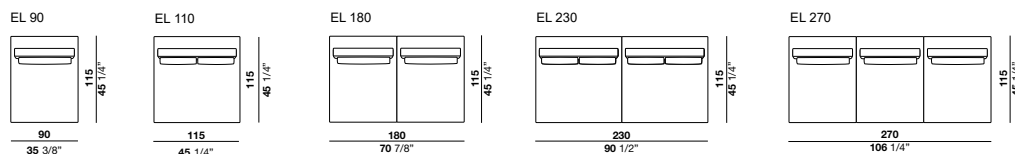

ELEMENTI TERMINALI / END ELEMENTS

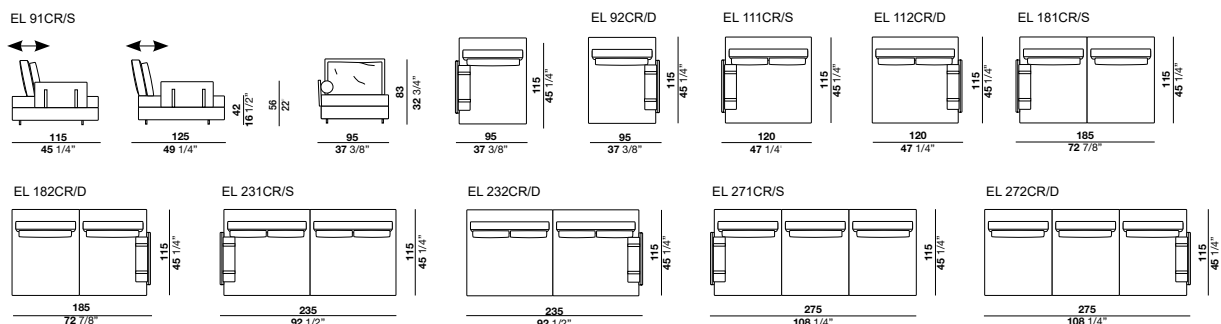

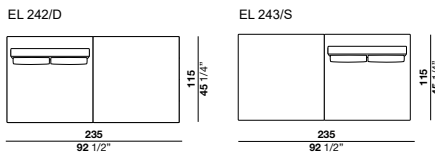
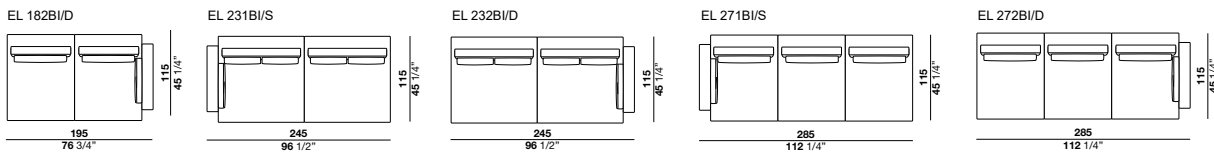
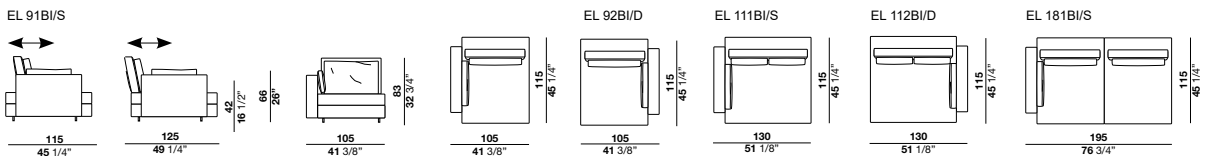
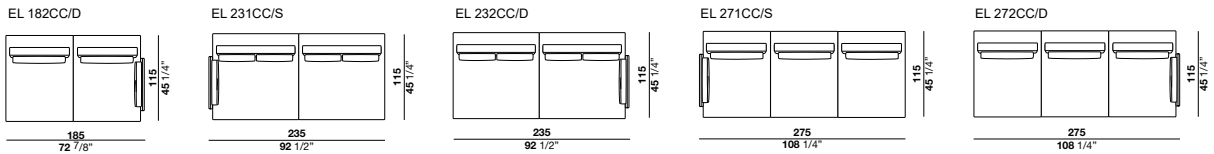
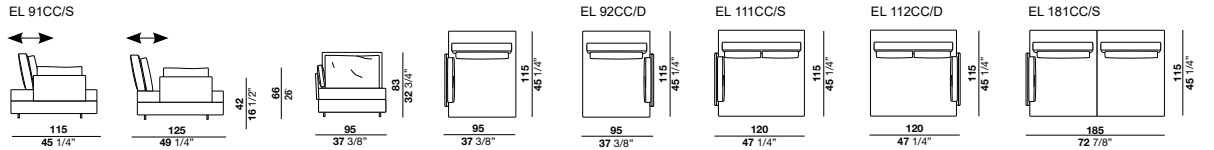

ANGOLI / CORNERS

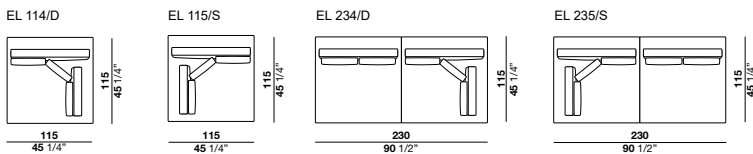

ANGOLI TERMINALI / CORNERS + END ELEMENTS

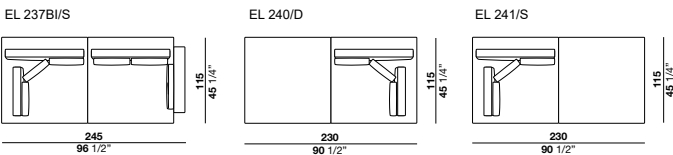
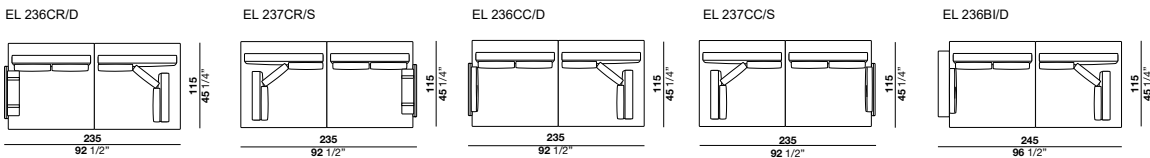

CHAISE LONGUES

EL 150

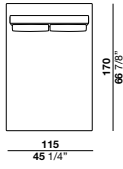

EL 151CR/S

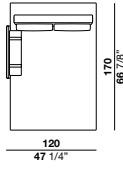

EL 152CR/D

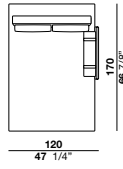

EL 151CC/S

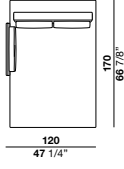

EL 152CC/D

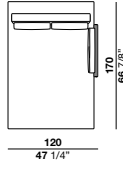

EL 151BI/S

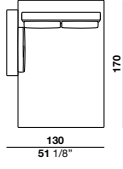

EL 152BI/D

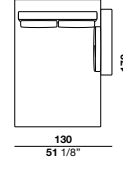

POUFF / OTTOMAN

EL 120

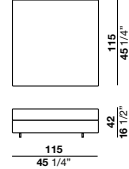

ELEMENTI INDIVIDUALI / INDIVIDUAL ELEMENTS

EL 93CR

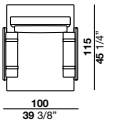

EL 183CR

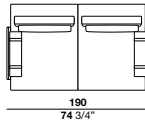

EL 233CR

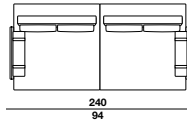

EL 238CR/D

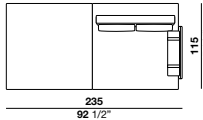

EL 239CR/S

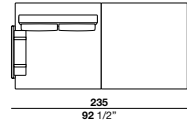

EL 273CR

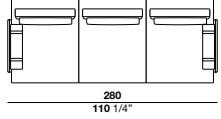

EL 93CC

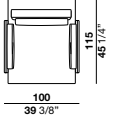

EL 183CC

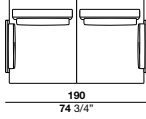

EL 233CC

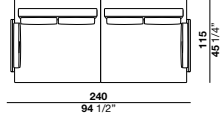

EL 238CC/D

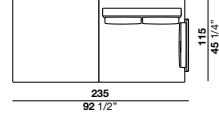

EL 239CC/S

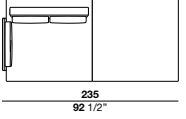

EL 273CC

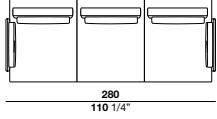

EL 93BI

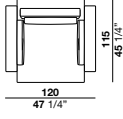

EL 183BI

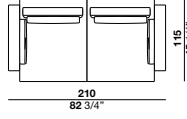

EL 233BI

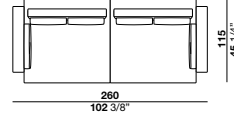

EL 238BI/D

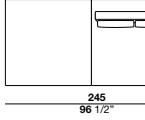

EL 239BI/S

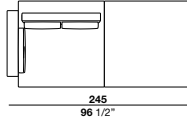

EL 273BI

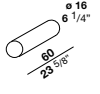
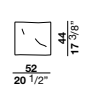
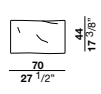
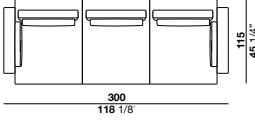

HEMINGWAY capitonné

ELEMENTI CENTRALI / CENTRAL UNITS

EL 590

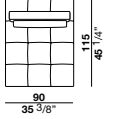

EL 610

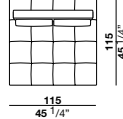

EL 680

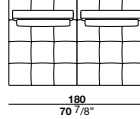

EL 730

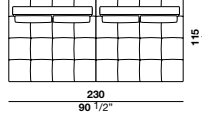

EL 770

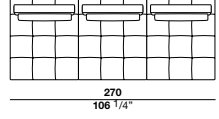

ELEMENTI TERMINALI / END ELEMENTS

EL 591CR/S

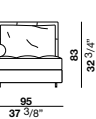
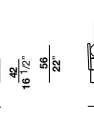
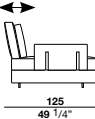
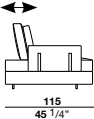

EL 592CR/D

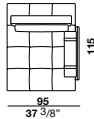

EL 611CR/S

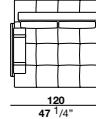

EL 612CR/D

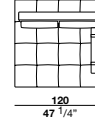

EL 681CR/S

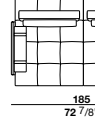

EL 682CR/D

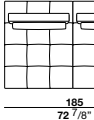

EL 731CR/S

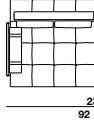

EL 732CR/D

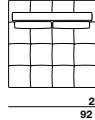

EL 771CR/S

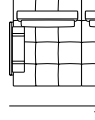

EL 772CR/D

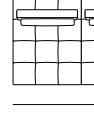

EL 591CC/S

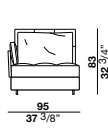
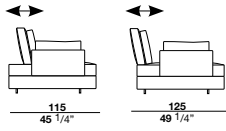

EL 592CC/D

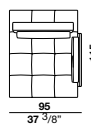

EL 611CC/S

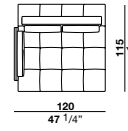

EL 612CC/D

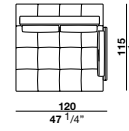

EL 681CC/S

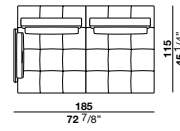

EL 682CC/D

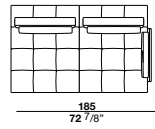

EL 731CC/S

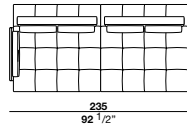

EL 732CC/D

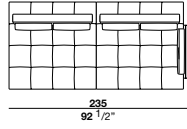

EL 771CC/S

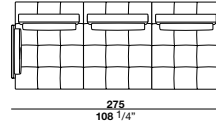

EL 772CC/D

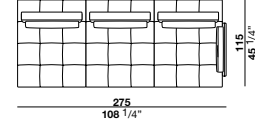

EL 591BI/S

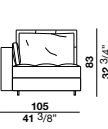
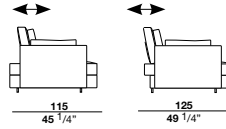

EL 592BI/D

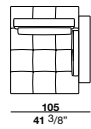

EL 611BI/S

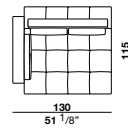

EL 612BI/D

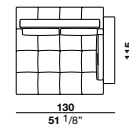

EL 681BI/S

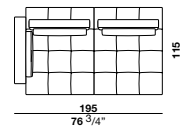

EL 682BI/D

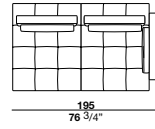

EL 731BI/S

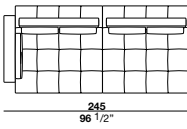

EL 732BI/D

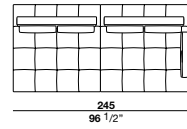

EL 771BI/S

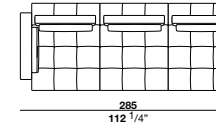

EL 772BI/D

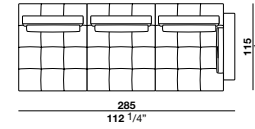

EL 742/D

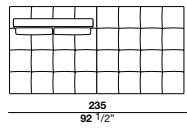

EL 743/S

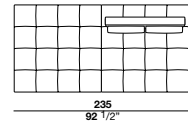

ANGOLI / CORNERS

EL 614/D

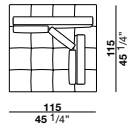

EL 615/S

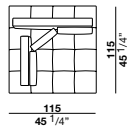

EL 734/D

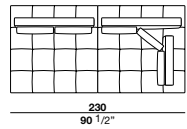

EL 735/S

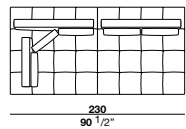

ANGOLI TERMINALI / CORNERS + END ELEMENTS

EL 736CR/D

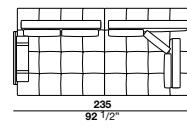

EL 737CR/S

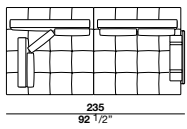

EL 736CC/D

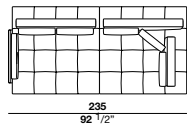

EL 737CC/S

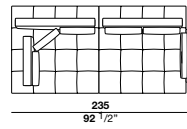

EL 736BI/D

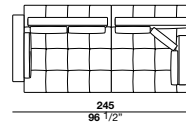

EL 737BI/S

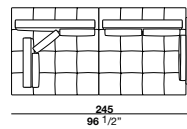

EL 740/D

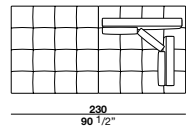

EL 741/S

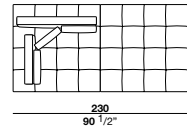

CHAISE LONGUES

EL 650

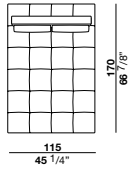

EL 651CR/S

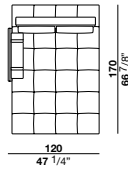

EL 652CR/D

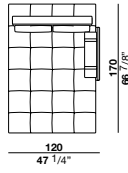

EL 651CC/S

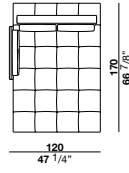

EL 652CC/D

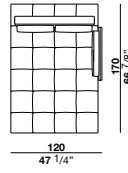

EL 651BI/S

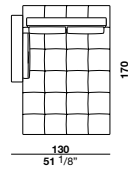

EL 652BI/D

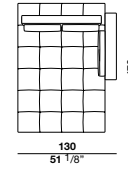

POUFF / OTTOMAN

EL 620

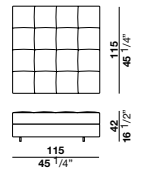

ELEMENTI INDIVIDUALI / INDIVIDUAL ELEMENTS

EL 593CR

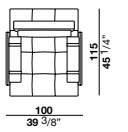

EL 683CR

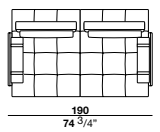

EL 733CR

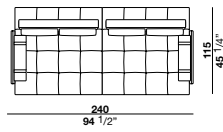

EL 738CR/D

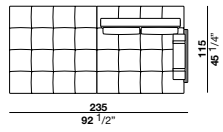

EL 739CR/S

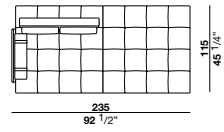

EL 773CR

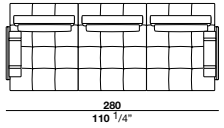

EL 593CC

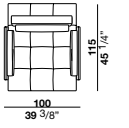

EL 683CC

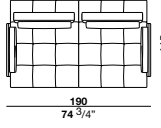

EL 733CC

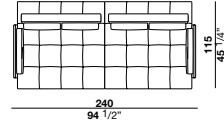

EL 738CC/D

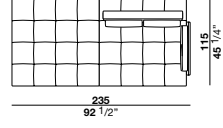

EL 739CC/S

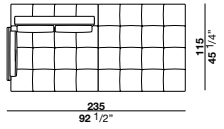

EL 773CC

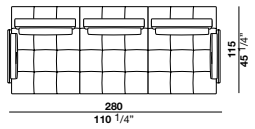

EL 593BI

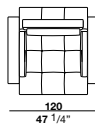

EL 683BI

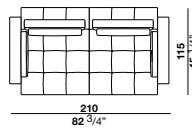

EL 733BI

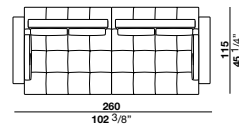

EL 738BI/D

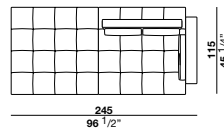

EL 739BI/S

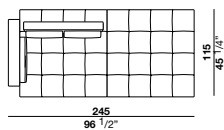

EL 773BI

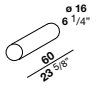
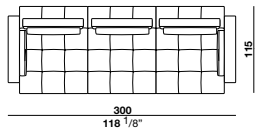

Finiture bracciolo in cuoio
 Finishes for armrest in coach hide
 Finitions accoudoir en cuir
 Ausführungen für Armlehne aus Sattelleder



CIPRIA - C



TABACCO - T



TESTA DI MORO - M